

3/2-Way; sub-base connection; DN 1,5–2,0 mm



Advantages/Benefits

- ▶ Coil can be changed easy with valve in place
- ▶ Coil can be locked in 4x 90° positions or move freely between, as required
- ▶ Medium is only in contact with the valve internals and body
- ▶ High-quality seal material FKM standard
- ▶ Wide range of cable plug options Type 2508

Design/Function

The valves are based on a modular concept comprising three basic elements; Valve assembly, push-over coil and standard cable plug. The valve assembly consists of a body to which the armature guide tube containing the plunger, seals and springs is attached. The coil is pushed over the guide tube and thus isolated from the medium. The medium is only in contact with the valve internals and body.

A wide selection of pipe and orifice sizes is offered. Valves are available in brass. All valves have high quality FKM seals as standard.

To simplify ordering, a wide selection of standard combinations of valve body, push over coil and standard cable plug can be ordered with one order number.

Cable plug options of Type 2508 are available to suit special electrical application requirements.

- The modular concept provides flexibility to meet applications requirements.
- The valve are interchangeable with Type 312.

Applications

Fluids

Neutral gases and liquids, e.g. compressed air, town gas, natural gas, water, hydraulic oil, petrol.

Suitable for technical vacuum

Applications

- Pneumatic control
- Shut-off, dosing, filling and ventilating
- Small-scale instruments, laboratory and measuring technology
- Welding technology

burkert
Easy Fluid Control Systems

Technical Data Type 6014

Circuit function

C 3/2-way valve,
when de-energized, outlet A
pressure relieved

Symbol

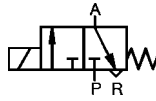

D 3/2-way valve,
when de-energized, outlet B
pressurized

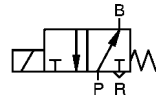

Operating Data (Valve)

Pressure range	0-16 bar (see specifications)
Port connection	Sub-base connection
Orifice	DN 1,5-2,0 mm
Fluid	Neutral gases and liquids, e.g. compressed air, town gas, neutral gas, water, hydraulic oil, petrol. Suitable for techn. vacuum.
Medium temperature	-10 bis +100 °C
Max. ambient temperature	+55 °C
Max. viscosity	21 mm ² /s
Response times	
opening	AC 10-15 ms; DC 15-20 ms
closing	AC 15-20 ms; DC 10-22 ms
Installation	as required, but preferably with solenoid system upright

Operating Data (Actuator)

Operating voltages	AC 24, 110, 230 V/50 Hz, DC 12, 24 V/=
Voltage tolerance	±10 %
Power consumption	AC inrush AC hold DC
32 mm-coil	24 VA 17 VA/8 W 8 W
Duty cycle	100% continuously rated
Duty cycle for multiple manifolds	60% for manifold mounting (30 min) or use 5W-version (on request)
Cycling rate	up to 1 200 c.p.m.
Rating with cable plug	IP 65
Electr. connection	Delivery standard: Cable plug DIN 43 650 A, 0-250 V. (Other versions see accessories)

Materials

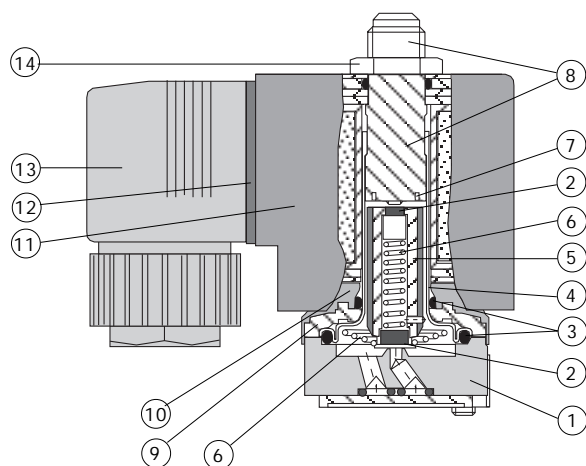

1 Valve body:	Brass
2 Plunger seal:	FKM
3 O-rings:	FKM
4 Armature guide tube:	1.4303
5 Plunger:	1.4105
6 Spring:	1.4310
7 Shading ring:	Cu (copper)
8 Stopper:	1.4105
9 Flange	Zn3 gl cC (surface)
10 Bonnet:	Durethan BKV30H
11 Coil:	PA (Polyamide)
12 Flat seal:	NBR
13 Cable plug:	PA (Polyamide)
14 Locknut:	9SMnPb28K (surface Zn5glcA)

Specifications - Ordering Chart (Other Versions on Request)

Type 6014; brass body (MS); coil 8W;

(with standard-cable plug 0-250 V AC/DC)

Circuit dunction ¹⁾	Orifice [mm]	Kv-value Wasser ²⁾ [m ³ /h]	Pressure range ³⁾ [bar]	Port connection	Voltage/frequency [V/Hz]	Weight [g]	Order-No. (without manual override)	Order-No. (with manual override)
C	1,5	0,07	0-16	Sub-base	24/=	320	126 154 J	126 157 M
					24/50		126 155 K	126 158 W
					110/50		126 156 L	126 159 X
					230/50		125 366 V	126 160 U
C	2,0	0,11	0-10	Sub-base	24/=	320	125 367 W	125 371 S
					24/50		125 368 F	125 372 T
					110/50		125 369 G	125 373 U
					230/50		125 370 D	125 374 V
D	2,0	0,11	0-10	Sub-base	24/=	320	126 161 R	
					24/50		126 162 J	
					110/50		126 163 K	
					230/50		125 383 P	

¹⁾ To use valves in other operations than specified, will change the specified maximum pressure range. Special applications on request.
²⁾ Measured with 6 bar upstream pressure and 1 bar pressure drop across the valve at +20 °C.
³⁾ All pressures quoted are gauge pressures with respect to the prevailing atmospheric pressure.

Dimensions (in mm)

Solenoid coil, 8W power consumption

Cable plug DIN 43650, form A (0-250 V AC/DC) delivery standard

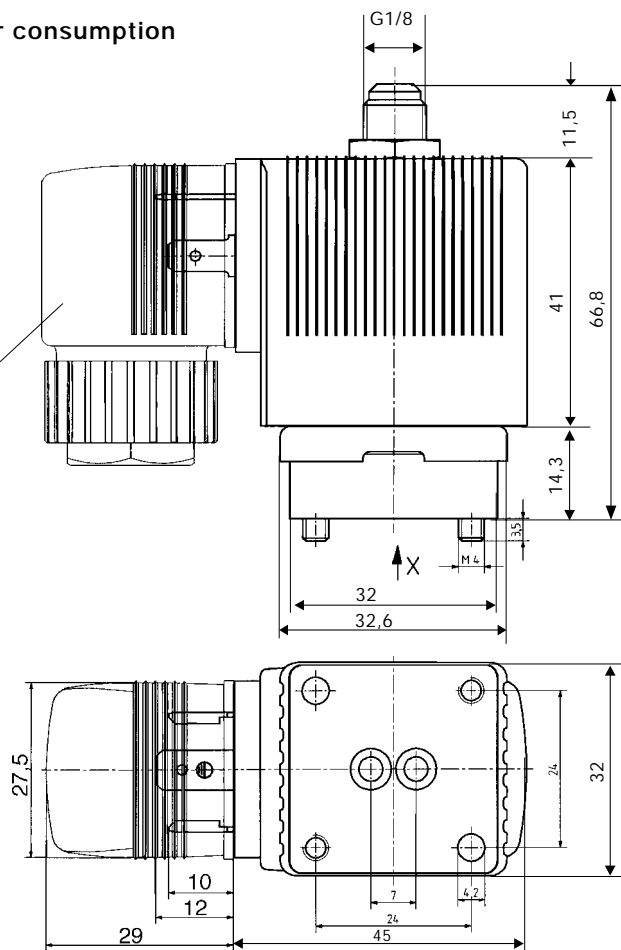

Dimensions Accessories (in mm)

Single manifold

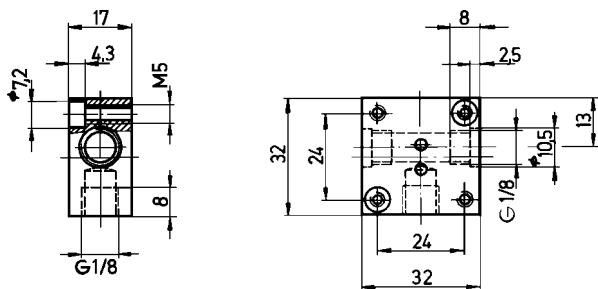

Multiple manifold

Manifolds mounted 5W-versions should be 100% continuously rated. 8W-versions should be limited to 60% duty cycle, 30 min switch-on time. The pressure port of the manifold is marked with P (R), the outlet port with A (B). Only similar ports can be coupled together. 3/2-way valves Type 6014 in circuit function C (not D and T) can be used with 2/2-way valve Type 6013, if the applied pressure corresponds to the valve. Unused connections to be plugged (see accessories). Manifolds may be coupled together using special push-fit O-ring connection nipples for linking the pressure inlets P (R). Manifolds joined together in this way should be securely mounted.

Multiple manifold

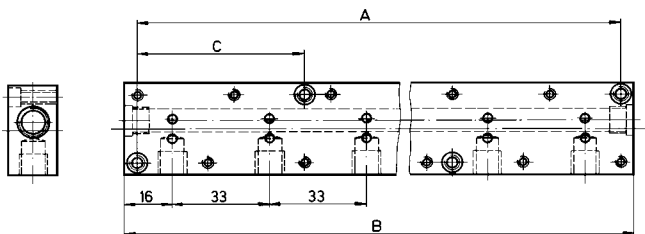

Standard cable plug

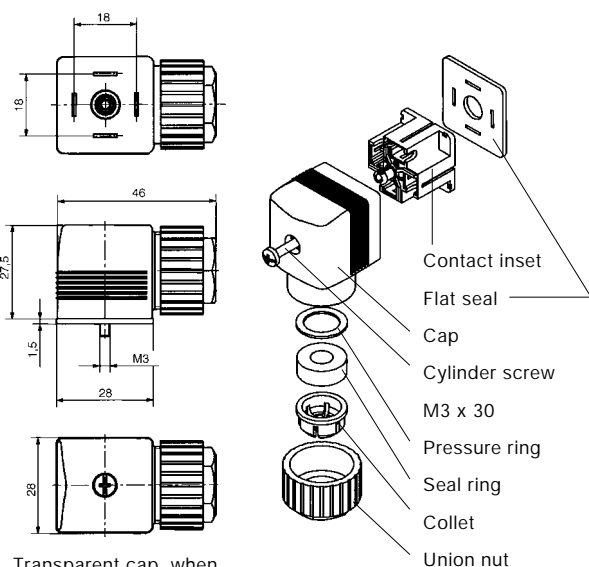

Transparent cap, when wired with LED

Ordering Chart for Manifolds/Accessories

Device/Accessory	Features	Order-No.
Single manifold	Aluminium	005 020 W
Multiple manifold (aluminium)	Hole spacing A Overall length B Hole spacing C	
2 valves	57 65 -	005 023 M
3 valves	90 98 -	005 286 S
4 valves	123 131 -	005 287 T
5 valves	156 164 57	005 035 R
6 valves	189 197 57	005 038 U
8 valves	255 263 57	005 386 W
10 valves	321 329 90	005 764 G
Connector nipples	with O-rings	005 040 A
Blanking screw	with seal ring, G 1/8	005 041 X
Blanking plug	with screws + O-ring	005 630 E

Ordering Chart for Accessories

Device/Accessory	Features	Order-No.
Cable-plugs¹⁾ Type 2508	Standard cable plug, 0-250 V AC/DC (standard-delivery) ¹⁾ with LED, 12-24 V AC/DC with LED, 100-120 V AC/DC with LED + varistor, 12-24 V AC/DC with LED + varistor, 100-120 V AC/DC with LED + varistor, 200-240 V AC/DC (optional wirings and connection specifications see data sheet Type 2508)	008 376 N 008 360 S 008 361 P 008 367 M 008 368 W 008 369 X

¹⁾ The standard cable plug (0-250 V AC/DC) Order-No. 008 376 N is part of the standard delivery. Ordering of optional cable plugs with separate ordering number.

A wide selection of further cable plugs is available (see special data sheet Type 2508)